



**ABBIGLIAMENTO
PROFESSIONALE
2023**

120 ANNI 4 GENERAZIONI

Nell'anno 1904 il comm. Pietro Barbieri fonda nel paesino di Fontane-Treviso la Tessitura Pietro Barbieri che produce tessuti di cotone, tela per lenzuola, tela per la camiceria e il Tessuto Massaua usato per la confezione degli abiti da lavoro.

La crescita dell'azienda viene ostacolata dallo scoppio della prima guerra mondiale che costringe l'azienda a chiusure e riaperture continue.

Dopo circa un ventennio di crescita nel dopoguerra, è la seconda guerra mondiale a bloccare le attività produttive specialmente nel Nord Italia .

Fortunatamente il "miracolo italiano" scoppiato nell'immediato dopoguerra, vede la Ditta espandere la sua attività raggiungendo nuovi mercati in Italia ed arrivando a dar lavoro a circa 150 persone, per la maggioranza donne, in un'area prettamente agricola. L'arrivo sui mercati italiani di tessuti di cotone proveniente dall'Estremo Oriente (Pakistan, India, etc) causò, alla fine degli anni '60 una crisi fortissima tra tutti i produttori italiani del settore, molti dei quali costretti alla chiusura.

Per cercare di far fronte alla difficile situazione l'azienda aprì al suo interno un laboratorio con una 20na di lavoratori che confezionavano abiti da lavoro con i tessuti prodotti dall'azienda.

Nell'anno 1992 la 4ª generazione della famiglia, Paola e Stefania Barbieri con il cugino Roberto Vendrami, fondano la **GLOBAL TRADING s.r.l.**, e iniziano l'importazione di Tessuti e Confezioni da lavoro da Paesi dell'Est Europa.

Negli anni a seguire l'azienda inizia la collaborazione con importanti confezionisti in Estremo Oriente che producono su modellistica **Global Trading** che impone anche gli accessori usati nella confezione.

Global Trading è un'azienda in continua evoluzione che sta sempre più allargando le sue vendite in Italia, proponendo un abbigliamento professionale che garantisce idoneità all'uso, durata nel tempo con ottime vestibilità e stile con un ottimo rapporto qualità prezzo.

La nostra nuova piattaforma web per effettuare gli ordini offre un sistema rapido per verificare gli stock a magazzino della merce e le date di arrivo dei riassortimenti.



In the year 1904, Mr. Pietro Barbieri founded the Tessitura Pietro Barbieri in the village of Fontane-Treviso, producing cotton fabrics clothes for sheets, clothes for shirts and Massaua fabric used for work clothes production.

The company's growth was hindered by the outbreak of the First World War, which forced it to continually close and reopen. After about twenty years of post-war growth, it was the Second World War that halted production activities, especially in northern Italy .

Fortunately, the 'Italian miracle' that broke out in the immediate post-war period saw the company expand its activities by reaching new markets in Italy and employing around 150 people, mostly women, in a purely agricultural area.

The arrival on the Italian markets of cotton fabrics from the Far East (Pakistan, India, etc.) caused, at the end of the 1960s, a severe crisis among all Italian producers in the sector, many of whom were forced to close.

To try to cope with the difficult situation, the company opened an in-house workshop with 20 or so workers who made work clothes from the fabrics produced by the company.

In 1992, the 4th generation of the family, Paola and Stefania Barbieri with their cousin Roberto Vendrami, founded **GLOBAL TRADING s.r.l.**, and began importing fabrics and workwear from Eastern European countries.

In the years that followed, the company began collaborating with important garment makers in the Far East who produce on **Global Trading** patterns and instructions on the accessories to be used in the garments.

Global Trading is a constantly evolving company that is increasingly expanding its sales in Italy, offering professional clothing that guarantees suitability for use, durability with excellent fit and style at an excellent value for money.

Our new web platform for placing orders offers a quick system for checking stock of goods and arrival dates of restocking.

l'azienda



forniture industriali	5
Pantalone Work	6-8
Pantalone Pockets	9
Maddox - NOVITA' 2023	10-12
Maddox bermuda	13
Pantalone Flexy	14-15
Pantalone Sigma	16-17
Pantalone Delta	18-19
Gilet Delta	20-21
Pantalone Ripstop	22-23
Bermuda Ripstop	24-25
Pantalone Stretch	26-29
Pantalone Gamma	30-31
Tuta Speedy	32-33
Salopette Speedy	34-35
Pantalone Speedy	36-37
Giubbino Speedy	38-39
Tuta Globo	40-41
Salopette Globo	42-43
Pantalone Globo	44-45
Giubbino Globo	46-47
Pantalone Globo tono su tono	48-49
Giubbino Globo tono su tono	50-51
Tuta Oro	52-55
Salopette Oro	56-57
Salopette Patrich	58
Pantalone Oro	59-60
Pantalone Kiparis	61
Giacca Oro	63
Giubbino Oro	64-65
Camice Kiparis	66-67
Camice Lux con bottoni a pressione	68
Camice donna con bottoni a pressione	69
Camice con bottoni a pressione	70-71
Camice Terital	72-73
Camicia Chambree	74
Jeans 14 once	75



forniture alberghiere e medico-sanitarie	77
Giacca Cuoco Lux	78-79
Casacca cotone collo V	80
Pantalone elastico vita	80
Cappello Cuoco	81
Bustina con retina	81
Cuffia con retina	81
Pantalone Cuoco con coulisse	82
Pantalone Cuoco	83
Calzature alberghiero-servizi	84-85
Casacca Paola	86
Casacca Andrea	87
Pantalone Dante	88
Bandana Adelina	89
Casacca Marco	89
Completo Colombo	90
Pantalone Batista	91
Casacca Ines	92
Casacca Gabi	93
Pantalone Alessi	94-95
Pantalone Cameriere	96
Papillon	97
Camicia Cameriere	98
Camicia Cameriera	99
Falde Sommelier	100-101
Falde corte in poliestere-cotone	102
Falde banconiere in poliestere-cotone	103
Falde Laccio Regolabile	104-105
Falde Kiparis con pettorina	106-108
Falde Kiparis con pettorina e tasca	107
Falde Patrich con pettorina	109
Falde Kiparis senza pettorina	110-111
Falde Patrich senza pettorina	110
Strofnaccio Torcione	112



forniture promozionali	113
Polo manica lunga	114
Polo mezza manica	115
Felpa con zip lunga	116
T-shirt mezza manica	117
Cappellino 5 pannelli	118
Cappellino 5 pannelli bicolore	119
Cappellino bandiera italiana	119
Berretto zuccotto in acrilico	120
Berretto zuccotto in pile	120
Cappellino con paraorecchie	121
Fascia pile multiuso	121
Giubbotto New Finland	122
Giubbotto New Scotland	123
Gilet Great Britain	124
Felpa New Singapore	125

forniture antinfortunistiche	127
Giubbino Alta Visibilità	128
Pantalone Alta Visibilità	128
Tuta Alta Visibilità	129
Salopette Alta Visibilità	129
Parka 5 usi Alta Visibilità	130
Parka Alta Visibilità	131
Gilet Alta Visibilità	131
Elmetto in polietilene	131
Stivali	132
Calzature antinfortunistiche	133-134



norme di sicurezza	135
conversione taglie	135





forniture
industriali

Work

Professional



AWKPANKA
kaki

AWKPA2NE
nero



AWKPANBL
blu

Pantalone Work

cod. AWKPAN/AWKPA2

Pantalone multitasche con elastico in vita, cerniera coperta, due tasche, due tasconi posteriori e due tasconi laterali tutti chiusi da pattina con velcro.

Composizione tessuto:

65% poliestere - 35% cotone

Grammatura tessuto: 240 gr/mq

Taglie:

dalla S alla XXXL

Box: da 20 pz. per taglia



AWKPANKA
kaki



AWKPANBL
blu



AWKPANGR
grigio



AWKPA2VE
verde militare



AWKPA2NE
nero

AWKPANGR
grigio

segue

Professional



AWKPA2VE
verde militare

Pantalone Work

cod. AWKPAN/AWKPA2

Pantalone multitasche con elastico in vita, cerniera coperta, due tasche, due tasconi posteriori e due tasconi laterali tutti chiusi da pattina con velcro.

Composizione tessuto:

65% poliestere - 35% cotone

Grammatura tessuto: 240 gr/mq

Taglie:

dalla S alla XXXL

Box: da 20 pz. per taglia

-  AWKPANKA
kaki
-  AWKPANBL
blu
-  AWKPANGR
grigio
-  AWKPA2VE
verde militare
-  AWKPA2NE
nero



Pantalone Pockets

cod. APKPAN

Pantalone multitasche con elastico in vita, cerniera coperta, due tasche, due tasconi posteriori e due tasconi laterali tutti chiusi da pattina con velcro.

Composizione tessuto:

100% cotone sanforizzato

Grammatura tessuto: 240 gr/mq

Taglie:

dalla S alla XXXL

Box: da 15 pz. per taglia

 APKPANGR
grigio

 APKPANBL
blu



APKPANGR
grigio

APKPANBL
blu



AMXPANNE
nero

Pantalone Maddox



cod. AMXPAN

Pantalone Maddox in tessuto stretch 4-way con inserti in poliestere Oxford, elastici laterali in vita, bottone antigraffio e cerniera coperta, due tasche davanti e due tasche posteriori di cui una applicata e una a fletto, due tasconi con pattina alle gambe, con gancio portabadge (non incluso), su gamba sinistra tasca obliqua per cellulare con pattina per una facile personalizzazione, cuciture a contrasto, profilo rinfrangente alle ginocchia.

Composizione tessuto:

92% nylon - 8% spandex

Grammatura tessuto: 220 gr/mq

Taglie:

dalla S alla XXXL

Box: da 10 pz. per taglia

-  AMXPANNE
nero
-  AMXPANBL
blu
-  AMXPANGR
grigio





AMXPANGR
grigio



Maddox



AMXPANBL
blu



Bermuda Maddox in arrivo



Flexy stretch

Professional

◀ **STRETCH** ▶



AFLPANBL
blu notte/nero

Pantalone Flexy

cod. AFLPAN

Pantalone bicolore multitasche con cuciture a contrasto, elastico in vita e soffietto alle ginocchia per un'ottima vestibilità, cerniera coperta, cavallo rinforzato, due tasche e taschino portamonete davanti, due tasconi posteriori di cui uno chiuso da pattina con velcro, tascone con pattina chiusa da velcro su gamba sinistra, tasca portametro con taschino supplementare chiuso da velcro e passante portamartello su gamba destra.

Composizione tessuto:

98% cotone - 2% elasthan

Grammatura tessuto: 245 gr/mq

Taglie:

dalla S alla XXXL

Box: da 10 pz. per taglia



AFLPANBL
blu notte/nero



AFLPANGR
grigio piombo/nero



◀ **STRETCH** ▶



AFLPANGR
grigio piombo/nero

Professional



ASGPANBL
blu/nero

Pantalone invernale Sigma

cod. ASGPAN

Pantalone invernale foderato, bicolore multitasche con cuciture a contrasto, elastico in vita e soffietto alle ginocchia per un'ottima vestibilità, cerniera coperta, cavallo rinforzato, due tasche e taschino portamonete davanti, due tasconi posteriori di cui uno chiuso da pattina con velcro, tascone con pattina chiusa da velcro su gamba sinistra, tasca portametro con taschino supplementare chiuso da velcro e passante portamartello su gamba destra.

Composizione tessuto:

100% cotone

Grammatura tessuto:

250 gr/mq ESTERNO

160 gr/mq INTERNO

Taglie:

dalla S alla XXXL

Box: da 10 pz. per taglia



ASGPANBL
blu/nero



ASGPANGR
grigio/nero

fodera interna

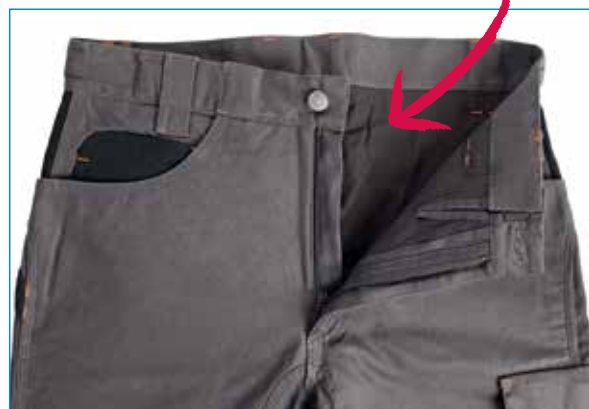

ASGPANGR
grigio/nero





Delta

Professional



ADLPANGR
grigio/nero

Pantalone Delta

cod. ADLPAN

Pantalone bicolore multitasche con cuciture a contrasto, elastico in vita e soffietto alle ginocchia per un'ottima vestibilità, cerniera coperta, cavallo rinforzato, due tasche e taschino portamonete davanti, due tasconi posteriori di cui uno chiuso da pattina con velcro, tascone con pattina chiusa da velcro su gamba sinistra, tasca portametro con taschino supplementare chiuso da velcro e passante portamartello su gamba destra.

Composizione tessuto:

100% cotone

Grammatura tessuto: 240 gr/mq

Taglie:

dalla S alla XXXL

Box: da 10 pz. per taglia

 ADLPANBL
blu/nero

 ADLPANGR
grigio/nero

ADLPANBL
blu/nero







Delta

Professional



ADLGILBL
blu/nero

ADLGILGR
grigio/nero



Gilet Delta

cod. ADLGIL

Gilet bicolore multitasche, profilo rinfrangente davanti, doppio taschino e tasca sul petto con pattina e chiusura in velcro, due tasconi di cui uno chiuso da cerniera, una tasca con zip e fodera rinforzata per utensili, ampia tasca posteriore con cerniera.

Composizione tessuto:

100% cotone

Grammatura tessuto: 240 gr/mq

Taglie:

dalla S alla XXXL

Box: 10 pz. per taglia

 ADLGILBL
blu/nero

 ADLGILGR
grigio/nero

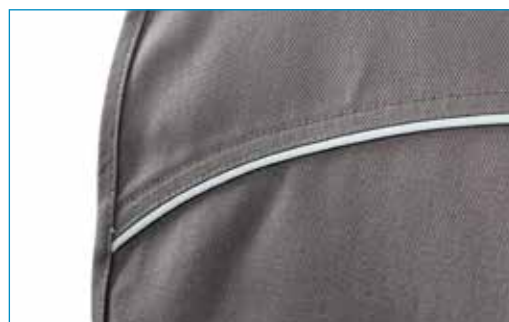



Ripstop

Professional



ARPPANGR
grigio

ARPPANBL
blu



TESSUTO RIPSTOP

Pantalone Ripstop

cod. ARPPAN

Pantalone multitasche in tessuto "Ripstop" antistrappo resistente alle lacerazioni, con elastico in vita nella parte posteriore, cerniera coperta, due tasche anteriori, due tasche posteriori con pattina e velcro, tascone con pattina e velcro gamba sinistra, tascone e portametro su gamba destra.

Composizione tessuto:

100% cotone lavorazione "Ripstop"

Grammatura tessuto:

200 gr/mq.

Taglie:

dalla S alla XXXL

Box: 10 pz. per taglia

ARPPANBL
blu

ARPPANGR
grigio







Ripstop

Professional



ARPERBG
blu/grigio



Bermuda Ripstop

cod. ARPERB

Bermuda multitasche, in tessuto "Ripstop" antistrappo resistente alle lacerazioni, con elastici laterali in vita, bottoni coperti, due tasche anteriori, due tasche posteriori con pattina e velcro, tascone con pattina e velcro gamba sinistra, tascone e portametro su gamba destra.

Composizione tessuto:

100% cotone, lavorazione "Ripstop"

Grammatura tessuto:

200 gr/mq.

Taglie:

bicolore: dalla S alla XXL

blu o grigio: dalla S alla XXXL

Box: 20 pz. per taglia

-  ARPERBG
blu/grigio
-  ARPERBL
blu
-  ARPERGR
grigio





ARPERBL
blu



ARPERGR
grigio



Stretch

Professional



ASTPANBL
blu

Pantalone Stretch

cod. ASTPAN

Pantalone Stretch con inserti tessuto "Indura", elastici laterali in vita, cerniera coperta, due tasche davanti e due tasche posteriori con pattina e velcro, tasca obliqua alla gamba sinistra con doppia tasca per cellulare con pattina per una facile personalizzazione, tascone con gancio portabadge su gamba destra, aperture per inserimento imbottiture alle ginocchia, profilo rinfrangente sotto la cintura posteriore e alle ginocchia.

Composizione tessuto:

98% cotone - 2% elasthan
inserti 100% poliestere

Grammatura tessuto:

240 gr/mq

Taglie: dalla S alla XXXL

Box: 10 pz. per taglia



ASTPANBL
blu



ASTPANGR
grigio



ASTPANNE
nero



◀ **STRETCH** ▶



ASTPANGR
grigio



new color

ASTPANNE
nero

segue ▶

Pantalone Stretch

cod. ASTPAN

Pantalone Stretch con inserti tessuto "Indura", elastici laterali in vita, cerniera coperta, due tasche davanti e due tasche posteriori con pattina e velcro, tasca obliqua alla gamba sinistra con doppia tasca per cellulare con pattina per una facile personalizzazione, tascone con gancio portabadge su gamba destra, aperture per inserimento imbottiture alle ginocchia, profilo rinfrangente sotto la cintura posteriore e alle ginocchia.

Composizione tessuto:

98% cotone - 2% elasthan
inserti 100% poliestere

Grammatura tessuto:

240 gr/mq

Taglie: dalla S alla XXXL

Box: 10 pz. per taglia



ASTPANBL
blu



ASTPANGR
grigio



ASTPANNE
nero



* protezioni non fornite



◀ **STRETCH** ▶



ideale per ricamo/stampa logo



Gamma

Professional



AGMPANGR
grigio/arancio



Pantalone Gamma

cod. AGMPAN

Pantalone multitasche bicolore modello "GAMMA" con elastico in vita, bottoni coperti, due tasche davanti con soffietto in contrasto, tasca posteriore e tasca su gamba destra con soffietto in contrasto, chiuse da pattina con velcro.

Composizione tessuto:

65% poliestere - 35% cotone

Grammatura tessuto: 235 gr/mq

Taglie: dalla S alla XXXL

Box: da 20 pz. per taglia

 AGMPANGR
grigio/arancio

 AGMPANNE
nero/grigio

 AGMPANBL
blu/rosso

AGMPANNE
nero/grigio

AGMPANBL
blu/rosso

Speedy stretch

Professional



ASPTUTGR
grigio piombo/nero

Tuta Speedy

cod. ASPTUT

Tuta lavoro modello "Speedy" con cerniera coperta, elastico in vita, velcro ai polsi, mezze maniche staccabili con cerniera, due tasche anteriori, due tasche posteriori con velcro, taschino con portapenne e portacellulare al petto, tascone con pattina su gamba sinistra, doppia tasca applicata su gamba destra, aperture per inserimento protezioni alle ginocchia.

Composizione tessuto:
98% cotone - 2% elasthan

Grammatura tessuto: 245 gr/mq

Taglie:
dalla S alla XXXL

Box: da 10 pz. per taglia



ASPTUTGR
grigio piombo/nero



mezze
maniche
staccabili



◀ STRETCH ▶



* protezioni
non fornite

Speedy stretch

Professional



ASPSALGR
grigio piombo/nero

Salopette Speedy

cod. ASPSAL

Salopette lavoro modello "Speedy" con cerniera laterale, bretelle elasticizzate, ganci in plastica, due tasche anteriori, due tasche posteriori con velcro, tascone frontale con portapenne e portacellulare, tascone con pattina su gamba sinistra, doppia tasca applicata su gamba destra, aperture per inserimento protezioni alle ginocchia.

Composizione tessuto:

98% cotone - 2% elasthan

Grammatura tessuto:

245 gr/mq

Taglie:

dalla S alla XXXL

Box: da 15 pz. per taglia



ASPSALGR
grigio piombo/nero

◀ **STRETCH** ▶





Speedy stretch

Professional



ASPPANGR
grigio piombo/nero

Pantalone Speedy

cod. ASPPAN

Pantalone lavoro "Speedy" con bottoni coperti, elastici laterali in vita, due tasche anteriori, due tasche posteriori con velcro, tascone con pattina su gamba sinistra, doppia tasca applicata su gamba destra, aperture per inserimento protezioni alle ginocchia.

Composizione tessuto:

98% cotone - 2% elasthan

Grammatura tessuto: 245 gr/mq

Taglie: dalla S alla XXXL

Box: da 10 pz. per taglia



ASPPANGR
grigio piombo/nero



◀ **STRETCH** ▶



* protezioni
non fornite

Speedy stretch

Professional



ASPGIUGR
grigio piombo/nero

Giubbino Speedy

cod. ASPGIU

Giubbino lavoro modello "Speedy" con cerniera coperta, elastici laterali al girovita, velcro ai polsi, maniche staccabili con cerniera, due tasconi, taschino con portapenne e portacellulare.

Composizione tessuto:

98% cotone - 2% elasthan

Grammatura tessuto: 245 gr/mq

Taglie: dalla S alla XXXL

Box: da 10 pz. per taglia



ASPGIUGR
grigio piombo/nero



◀ **STRETCH** ▶



representazione
con maniche staccate

Professional



AGLTUTBL
blu/grigio

Tuta Globo

cod. AGLTUT

Tuta lavoro modello "Globo" con cerniera coperta, elastico in vita, velcro ai polsi, mezze maniche staccabili con cerniera, due tasche anteriori, due tasche posteriori con velcro, taschino con portapenne e portacellulare al petto, tascone con pattina su gamba sinistra, doppia tasca applicata su gamba destra, aperture per inserimento protezioni alle ginocchia.

Composizione tessuto:

100% cotone sanforizzato con inserti in poliestere cotone

Grammatura tessuto: 280/290 gr/mq

Taglie:

dalla S alla XXXL

Box: da 10 pz. per taglia



AGLTUTBL
blu/grigio

mezze maniche
staccabili





* protezioni
non fornite



Globo

Professional



AGLSALBL
blu/grigio

Salopette Globo

cod. AGLSAL

Salopette lavoro modello "Globo" con cerniera laterale, bretelle elasticizzate, ganci in plastica, due tasche anteriori, due tasche posteriori con velcro, tascone frontale con portapenne e portacellulare, tascone con pattina su gamba sinistra, doppia tasca applicata su gamba destra, aperture per inserimento protezioni alle ginocchia.

Composizione tessuto:

100% cotone sanforizzato con inserti in poliestere cotone

Grammatura tessuto:

280/290 gr/mq

Taglie:

dalla S alla XXXL

Box: da 12 pz. per taglia



AGLSALBL
blu/grigio







Globo

Professional



AGLPANBL
blu/grigio

Pantalone Globo

cod. AGLPAN

Pantalone lavoro "Globo" con bottoni coperti, elastici laterali in vita, due tasche anteriori, due tasche posteriori con velcro, tascone con pattina su gamba sinistra, doppia tasca applicata su gamba destra, aperture per inserimento protezioni alle ginocchia.

Composizione tessuto:

100% cotone sanforizzato con inserti in poliestere cotone

Grammatura tessuto: 280/290 gr/mq

Taglie:

dalla S alla XXXL

Box: 20 pz. per taglia



AGLPANBL
blu/grigio







Globo

Professional

Giubbino Globo

cod. AGLGIU

Giubbino lavoro modello "Globo" con cerniera coperta, elastici laterali al girovita, velcro ai polsi, maniche staccabili con cerniera, due tasconi, taschino con portapenne e portacellulare.

Composizione tessuto:

100% cotone sanforizzato con inserti in poliestere cotone

Grammatura tessuto:

280/290 gr/mq

Taglie:

dalla S alla XXXL

Box: 15 pz. per taglia



AGLGIUBL
blu/grigio



AGLGIUBL
blu/grigio



maniche staccabili



Professional



AGLPANGR
grigio

Pantalone Globo tono su tono

cod. AGLPAN

Pantalone lavoro "Globo" con bottoni coperti, elastici laterali in vita, due tasche anteriori, due tasche posteriori con velcro, tascone con pattina su gamba sinistra, doppia tasca applicata su gamba destra, aperture per inserimento protezioni alle ginocchia.

Composizione tessuto:

100% cotone sanforizzato

Grammatura tessuto:

240 gr/mq

Taglie:

dalla S alla XXXL

Box: 20 pz. per taglia



AGLPANGR
grigio chiaro/scuro





* protezioni non fornite





Professional

Giubbino Globo tono su tono

cod. AGLGIU

Giubbino lavoro modello "Globo" con cerniera coperta, elastici laterali al girovita, velcro ai polsi, maniche staccabili con cerniera, due tasconi, taschino con portapenne e portacellulare.

Composizione tessuto:

100% cotone sanforizzato

Grammatura tessuto:

240 gr/mq

Taglie:

dalla S alla XXXL

Box: 15 pz. per taglia



AGLGIUGR
grigio chiaro/scuro



AGLGIUGR
grigio





representazione
con maniche staccate

ATUTORBL
blu

Tuta Oro

cod. ATUTOR/ATUTO2

Tuta lavoro modello "Oro" con cerniera coperta in plastica e tirazip in metallo, quattro tasche, elastico in vita e ai polsi e portametro.

Composizione tessuto:

100% cotone sanforizzato

Grammatura tessuto: 260 gr/mq

Taglie:

per colore blu: dalla 44 alla 64

per colore bianco, arancio, grigio, verde,

royal: dalla S alla XXXL

Box: da 10 pz. per taglia

	ATUTO2WH bianco
	ATUTO2RY royal
	ATUTORBL blu
	ATUTO2GR grigio
	ATUTO2VE verde
	ATUTO2AR arancio





ATUT02WH
bianco



ATUT02GR
grigio



segue



Oro



ATUTO2AR
arancio



ATUTO2RY
royal



Tuta Oro

cod. ATUTOR/ATUTO2

Tuta lavoro modello "Oro" con cerniera coperta in plastica e tirazip in metallo, quattro tasche, elastico in vita e ai polsi e portametro.

Composizione tessuto:

100% cotone sanforizzato

Grammatura tessuto: 260 gr/mq







Taglie:

per colore blu: dalla 44 alla 64

per colore bianco, arancio, grigio, verde,

royal: dalla S alla XXXL

Box: da 10 pz. per taglia

	ATUTO2WH bianco		ATUTO2GR grigio
	ATUTO2RY royal		ATUTO2VE verde
	ATUTORBL blu		ATUTO2AR arancio



ATUTO2VE
verde

ASALORBL
blu

Salopette Oro

cod. ASALOR/ASAL02

Salopette modello "Oro", con elastico sul retro e sulle bretelle, quattro tasche, portametro e ganci in plastica.

Composizione tessuto:

100% cotone sanforizzato

Grammatura tessuto:

260 gr/mq

Taglie:

per colore blu: dalla 44 alla 64

per colore verde, grigio: dalla S alla XXXL

Box: da 15 pz. per taglia

	ASALORBL blu
	ASAL02GR grigio
	ASAL02VE verde



ASAL02VE
verde



ASAL02GR
grigio



segue



ASALPAWH
bianco

Salopette Patrich

cod. ASALPA

Salopette modello "Patrich", con elastico sul retro e sulle bretelle, quattro tasche, portametro e ganci in plastica.

Composizione tessuto:

100% cotone sanforizzato

Grammatura tessuto:

200 gr/mq

Taglie:

dalla S alla XXXL

Box: da 15 pz. per taglia



ASALPAWH
bianco



light fabric



Pantalone Oro

cod. APANOR/APAN02

Pantalone lavoro modello "Oro" con elastico in vita, bottoni coperti, tre tasche e portametro.

Composizione tessuto:
100% cotone sanforizzato

Grammatura tessuto:
260 gr/mq

Taglie:
per colore blu: dalla 44 alla 64
per colore verde, grigio: dalla S alla XXXL

Box: da 20 pz. per taglia

	APANORBL blu
	APAN02GR grigio
	APAN02VE verde



APANORBL
blu

segue

APAN02VE
verdeAPAN02GR
grigio

Pantalone Oro

cod. APANOR/APANO2

Pantalone lavoro modello "Oro" con elastico in vita, bottoni coperti, tre tasche e portametro.

Composizione tessuto:
100% cotone sanforizzato

Grammatura tessuto:
260 gr/mq

Taglie:
per colore blu: dalla 44 alla 64
per colore verde, grigio: dalla S alla XXXL

Box: da 20 pz. per taglia



APANORBL
blu



APAN02GR
grigio



APAN02VE
verde



Pantalone Kiparis

cod. BPANKI

Pantalone lavoro modello "Kiparis" con elastico in vita, bottoni coperti, tre tasche, portametro su gamba destra e tascone con pattina velcro su gamba sinistra.

Composizione tessuto:

100% cotone sanforizzato

Grammatura tessuto:

220 gr/mq

Taglie: da 42 a 62

Box: da 25 pz. per taglia



BPANKIBI
bianco



tascone su gamba sinistra



BPANKIBI
bianco



Giacca Oro

cod. AGIAOR

Giacca lavoro modello "ORO" con bottoni coperti e tre tasche.

Composizione tessuto:
100% cotone sanforizzato

Grammatura tessuto:
260 gr/mq

Taglie:
dalla 44 alla 64

Box: da 15 pz. per taglia

 AGIAORBL
blu



AGIAORBL
blu



Giubbino Oro cod.

AGIUOR/AGIU02

Giubbino lavoro modello "Oro" con bottoni coperti e due tasche.

Composizione tessuto:

100% cotone sanforizzato

Grammatura tessuto:

260 gr/mq

Taglie:

per colore blu: dalla 44 alla 64
per colore verde e grigio:
dalla S alla XXXL

Box: da 15 pz. per taglia

-  AGIUORBL
blu
-  AGIU02GR
grigio
-  AGIU02VE
verde

AGIU02GR
grigio



AGIU02VE
verde



AGIUORBL
blu





ACAMKIBL
blu

Camice Kiparis

cod. ACAMKI

Camice lavoro "Kiparis" con tre tasche, copribottone ed elastico ai polsi.

Composizione tessuto:

100% cotone sanforizzato

Grammatura tessuto: 240 gr/mq

Taglie:

dalla S alla XXXL

Box: da 15 pz. per taglia

-  ACAMKIBL
blu
-  ACAMKIAZ
royal
-  ACAMKIVE
verde
-  ACAMKIBI
bianco
-  ACAMKIGR
grigio





ACAMKIVE
verde



ACAMKIAZ
royal



ACAMKIBI
bianco



ACAMKIGR
grigio





ACAUPAWH
bianco

Camice Lux con bottoni a pressione

cod. ACAUPA

Camice lavoro "Lux" con bottoni a pressione coperti, tre tasche anteriori, elastico ai polsi.

Composizione tessuto:

100% cotone sanforizzato

Grammatura tessuto:

220 gr/mq

Taglie:

dalla XS alla XXL

Box: da 15 pz. per taglia



ACAUPAWH
bianco

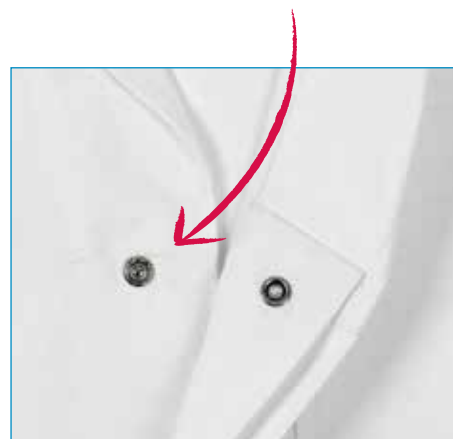



Camice donna con bottoni a pressione

cod. ACADPC

Camice da donna con bottoni a pressione coperti, tre tasche anteriori, elastico ai polsi.

Composizione tessuto:

65% poliestere - 35% cotone

Grammatura tessuto: 130 gr/mq

Taglie: dalla S alla XL

Box: 30 pz. per taglia



ACADPCWH
bianco



ACADPCWH
bianco



Camice con bottoni a pressione

cod. ACAUPC

Camice da lavoro con bottoni a pressione coperti, tre tasche anteriori, elastico ai polsi.

Composizione tessuto:

65% poliestere - 35% cotone

Grammatura tessuto: 130 gr/mq

Taglie:

dalla S alla XXL

Box: 30 pz. per taglia

	ACAUPCWH bianco
	ACAUPCGR grigio
	ACAUPCBL blu
	ACAUPCNE nero

ACAUPCBL
blu



ACAUPCNE
nero



ACAUPCWH
bianco



ACAUPCGR
grigio





ACAMPCVE
verde

Camice Terital

cod. ACAMPC

Camice lavoro con tre tasche, copribottone ed elastico ai polsi.

Composizione tessuto:

65% poliestere - 35% cotone





Grammatura tessuto:

130 gr/mq

Taglie:

per colore royal e verde: dalla S alla XXXL
per colore bianco e blu: dalla XS alla XXXL

Box: da 20 pz. per taglia

-  ACAMPCBL
blu
-  ACAMPCRY
royal
-  ACAMPCVE
verde
-  ACAMPCBI
bianco

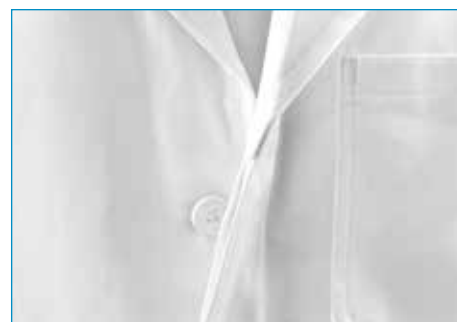

ACAMPCBL
blu



ACAMPCBI
bianco



ACAMPCRY
royal





CCAUXML
manica lunga

CCAUXMM
mezza manica



Camicia Chambree

cod. CCAUX ML
manica lunga

cod. CCAUX MM
mezza manica

Camicia Chambree "Job Style" con
due taschini e portapenne.

Composizione tessuto:
100% cotone

Taglie:
dalla S alla XXXL

Box: da 10 pz. per taglia



Jeans 14 once

cod. AJTRAD14

Jeans 14 once, stone-washed.

Composizione tessuto:

100% cotone

Taglie:

dalla 42 alla 60

Box: da 10 pz. per taglia



AJTRAD14



forniture
alberghiere
e medico-sanitarie



Giacca Cuoco Lux

cod. BGILUX

Giacca da cuoco manica lunga, doppio petto, chiusura con bottoni estraibili, taschino lato cuore e doppio taschino su manica sinistra.

Composizione tessuto:
100% cotone

Taglie:
dalla S alla XXL

Box: 15 pz. per taglia

Colore nero: ad esaurimento



BGILUXNE
nero





BGILUXBI
bianco

APANCOBI
biancoACASCOBI
bianco

Casacca cotone collo V

cod. ACASCO

Casacca cotone collo a V, manica americana e tre tasche.

Composizione tessuto: 100% cotone sanforizzato

Grammatura tessuto: 220 gr/mq

Taglie: dalla XS alla XXXL

Box: da 20 pz. per taglia

ACASCOBI
bianco

Pantalone elastico vita

cod. APANCO

Pantalone bianco con elastico in vita, coulisse e due tasche.

Composizione tessuto: 100% cotone sanforizzato

Grammatura tessuto: 220 gr/mq

Taglie: dalla XS alla XXXL

Box: da 20 pz. per taglia

APANCOBI
bianco



Y18177NE
nero

Y18177BI
bianco

Bustina con retina

cod. BCAP01BI (bianco)
Bustina con retina.

Composizione tessuto:
100% cotone, retina in poliestere

Taglie: unica

Box: da 100 pz.



Cappello Cuoco

cod. Y18177
Cappello da cuoco,
chiusura con velcro.

Composizione tessuto:
100% cotone

Taglie: unica

Box: da 100 pz.



Cuffia con retina

cod. BCAP02BI (bianco)
Cuffia con retina, elastico posteriore.

Composizione tessuto:
100% cotone, retina in poliestere

Taglie: unica

Box: da 100 pz.



Strofnaccio Torcione

cod. BSTROF

vedi pag. 112



Pantalone Cuoco con coulisse

cod. BPANCL

Pantalone da cuoco con coulisse interna, elastico in vita, due tasche davanti e una tasca dietro.

Composizione tessuto:

100% cotone

Taglie: dalla XS alla XXXL

Box: 15 pz. per taglia



BPANCLBN
bianco/nero



**Pantalone
elastico vita**

cod. APANCOBI

vedi pag. 80

Pantalone Cuoco

cod. BPANPE

Pantalone "Pepito" tinto filo, con cerniera coperta, due tasche davanti una tasca dietro.

Composizione tessuto:

100% cotone sanforizzato

Taglie: dalla 42 alla 62

Box: 20 pz. per taglia



BPANPEBN
bianco/nero



Pantalone Kiparis

cod. BPANKIBI

vedi pag. 61



Structure
NUW20112
nero



Structure cod. NUW20112 **Response Grip** cod. NUW20032

Tomaia: Safety Dry, idrorepellente, traspirante

Puntale: AirToe Composite forato con membrana traspirante

Antiperforazione: non presente

Taglie: dalla 35 alla 48

Box: da 10 paia per taglia



Response Grip
NUW20032
bianco



Nurse Grip cod. NUW20031

Tomaia: Microfibra Lucky

Puntale: AirToe Composite forato con membrana traspirante

Antiperforazione: non presente

Taglie: dalla 35 alla 48

Box: da 10 paia per taglia



Nurse Grip
NUW20031
bianco



Super cod. NUW60061

Surge Grip cod. NUW60041

Tomaia: Microfibra Lucky

Puntale: AirToe Composite forato con membrana traspirante

Antiperforazione: non presente

Taglie: dalla 35 alla 48

Box: da 10 paia per taglia



Super
NUW60061
nero



cinturino regolabile



Surge Grip
NUW60041
bianco



Breeze Grip cod. NUW60011

Sinergy Grip cod. NUW60021

Tomaia: Microfibra Lucky

Puntale: AirToe Composite forato con membrana traspirante

Antiperforazione: non presente

Taglie: dalla 35 alla 42

Box: da 10 paia per taglia



Breeze Grip
NUW60011
bianco



cinturino regolabile



Sinergy Grip
NUW60021
bianco





BW401295
bianco/azzurro

Casacca Paola stretch

Cod. BW4012

Casacca donna stretch con inserti colorati, una tasca superiore e due doppie inferiori, di cui una chiusa con bottone a pressione.

Composizione tessuto:

63% poliestere - 35% cotone - 2% elasthan

Grammatura tessuto: 165 gr/mq

Taglie: dalla 40 alla 60

Box: da 30 pz. per taglia

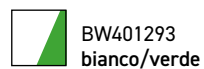
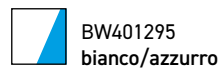

◀ **STRETCH** ▶



BW401293
bianco/verde



BW401294
bianco/fuxia



Casacca Andrea stretch

Cod. BW4010

Casacca donna stretch tinta unita, collo a V, due tasche frontali di cui una con porta penna.





Composizione tessuto:

63% poliestere - 35% cotone - 2% elasthan

Grammatura tessuto: 165 gr/mq

Taglie: dalla 40 alla 60

Box: da 30 pz. per taglia

	BW401001 blu navy		BW401042 verde
	BW401000 bianco		BW401040 fuxia
	BW401041 azzurro		



◀ **STRETCH** ▶





Pantalone Dante unisex stretch

Cod. BW4402

Pantalone unisex stretch tinta unita con elastico e coulisse, multitasche, porta badge con elastico

Composizione tessuto:

63% poliestere - 35% cotone - 2% elasthan

Grammatura tessuto: 165 gr/mq

Taglie: dalla XS alla 3XL

Box: da 30 pz. per taglia



BW440200
bianco



BW440240
fuxia



BW440241
azzurro



BW440201
blu navy



BW440242
verde

◀ **STRETCH** ▶



BW440200
bianco



BW440242
verde



BW440240
fuxia



BW440201
blu navy



◀ **STRETCH** ▶

Bandana Adelina unisex stretch

Cod. BW4701

Bandana stretch tinta unita con inserto parasudore e chiusura con lacci

Composizione tessuto:

63% poliestere - 35% cotone - 2% elasthan

Grammatura tessuto: 165 gr/mq

Taglie: unica

Box: da 30 pz.



BW470101
blu navy

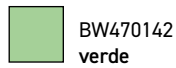

BW470142
verde



BW470141
azzurro



BW470140
fuxia

BW470101
blu navy



BW470141
azzurro

BW470140
fuxia

BW470142
verde



BW400901
blu navy

Casacca Marco stretch

Cod. BW4009

Casacca uomo stretch una tasca superiore e due doppie inferiori, di cui una chiusa con bottone a pressione.

Composizione tessuto:

63% poliestere - 35% cotone - 2% elasthan

Grammatura tessuto: 165 gr/mq

Taglie: dalla S alla 3XL

Box: da 30 pz. per taglia

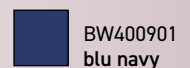

BW400901
blu navy

◀ **STRETCH** ▶



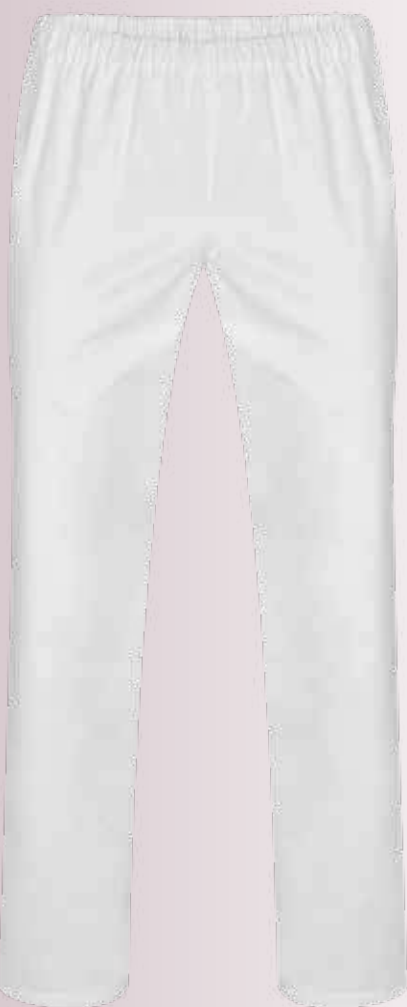

BW430200
bianco

Completo Colombo unisex

Cod. BW4302

Completo unisex taglio confortevole. Casacca con mezza manica, collo a V tre tasche. Pantalone con elastico in vita, con e senza coulisse, tasca posteriore.

Composizione tessuto:

65% poliestere - 35% cotone

Grammatura tessuto: 180 gr/mq

Taglie: dalla XS alla 3XL

Box: da 30 pz. per taglia



BW430200
bianco



BW430204
piombo



BW430208
bordeaux



BW430201
blu navy



BW430257
verde



BW430201
blu navy

BW430208
bordeaux

BW430204
piombo

BW430257
verde



Pantalone Batista unisex

Cod. BW4401

Pantalone unisex tinta unita con elastico e tasca posteriore

Composizione tessuto:

65% poliestere - 35% cotone

Grammatura tessuto: 160 gr/mq

Taglie: dalla XS alla 3XL

Box: da 30 pz. per taglia

ad esaurimento scorte

 BW440100 bianco	 BW440107 nero	 BW440113 azzurro
 BW440108 bordeaux	 BW440101 blu navy	 BW440114 verde



BW440101
blu navy

BW440108
bordeaux



BW440114
verde



BW440107
nero



BW440113
azzurro



BW440100
bianco





BW400223
verdino

Casacca Ines slim fit

Cod. BW4002

Casacca donna Slim Fit, collo a V, manica corta, con due tasche frontali, spacchi laterali, sfiancata sulla schiena.

Composizione tessuto:

65% poliestere - 35% cotone

Grammatura tessuto: 160 gr/mq

Taglie: dalla XS alla 3XL

Box: da 30 pz. per taglia



BW400200
bianco



BW400213
azzurro

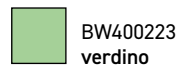

BW400223
verdino

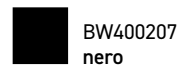

BW400207
nero



BW400213
azzurro



BW400207
nero



BW400200
bianco

Casacca Gabi

Cod. BW4001

Casacca donna con bottoni trasparenti, una tasca superiore e due doppie inferiori, leggermente sfiancata e lunghezza fino ai fianchi.

Composizione tessuto:

65% poliestere - 35% cotone

Grammatura tessuto: 160 gr/mq

Taglie: dalla XS alla 3XL

Box: da 30 pz. per taglia



BW400100
bianco



BW400189
azzurro



BW400196
blu navy



BW400189
azzurro



BW400100
bianco



BW400196
blu navy



BW440623
verdino

Pantalone Alessi unisex

Cod. BW4406

PPantalone unisex tinta unita con elastico in vita, coulisse, due tasche davanti e una tasca posteriore

Composizione tessuto:

65% poliestere - 35% cotone

Grammatura tessuto: 160 gr/mq

Taglie: dalla XS alla 3XL

Box: da 30 pz. per taglia



BW440600
bianco

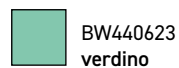

BW440623
verdino



BW440601
blu navy

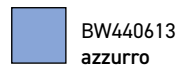

BW440613
azzurro



BW440600
bianco



BW440601
blu navy



BW440613
azzurro







Pantalone Cameriere

cod. BPANPO

Pantalone da cameriere, cerniera coperta, due tasche davanti e due tasche posteriori a filetto con bottone.

Composizione tessuto:

100% poliestere

Taglie:

dalla 40 alla 60

Box: 10 pz. per taglia



BPANPONE
nero

BPANPONE
nero



Papillon

cod. BPAPVI

Papillon da cameriere con gancio in metallo.

Composizione tessuto:
100% poliestere

Taglie: unica

Box: da 50 pz.



BPAPVIBO
bordeaux



BPAPVINE
nero



BPAPVIBI
bianco



BPAPVIBO
bordeaux



BPAPVINE
nero



BPAPVIBI
bianco

Camicia Cameriere

cod. CCAFAN ML
manica lunga

cod. CCAFAN MM
mezza manica

Camicia per cameriere bianca in
poliestere-cotone.

Composizione tessuto:
65% poliestere - 35% cotone

Taglie:
dalla XS alla XXXL

Box: da 6 pz. per taglia

CCAFANML/MM
bianco



CCAFANML
manica lunga



CCAFANMM
mezza manica

Camicia Cameriera

cod. CCADON ML
manica lunga

cod. CCADON MM
mezza manica

Camicia per cameriera bianca in
poliestere - cotone.

Composizione tessuto:
65% poliestere - 35% cotone

Taglie:
dalla XS alla XXL

Box: da 6 pz. per taglia

CCADONML/MM
bianco



CCADONMM
mezza manica



CCADONML
manica lunga



Falde Sommelier

cod. BFPOPT

Falde con pettorina, con bottoni per regolazione al collo, taschino doppio e due tasche.

Composizione tessuto:

100% poliestere

Box: da 25 pz.

 BFPOPTBO
bordeaux

 BFPOPTNE
nero





BFPOPTNE
nero



BFPOPTBO
bordeaux



Falde corte in poliestere-cotone

cod. BFPCCO

Falde senza pettorina con tasca frontale doppia.

Composizione tessuto:

65% poliestere - 35% cotone

Grammatura tessuto: 240 gr/mq

Misure indicative: cm 68x40h

Box: da 50 pz.



BFPCCONE
nero

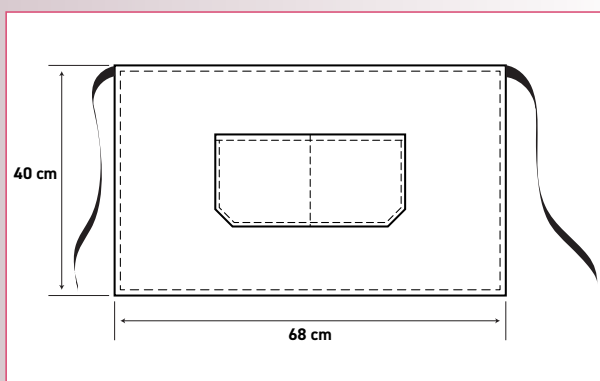

BFPCCONE
nero

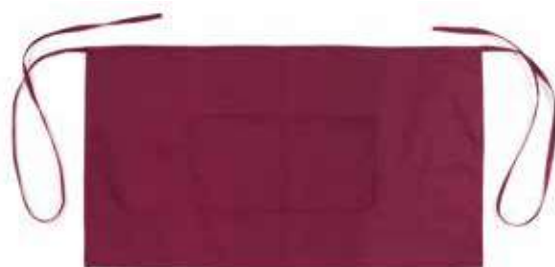
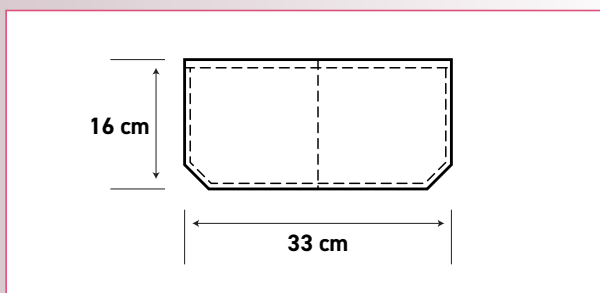

BFPCCOBO
bordeaux

Falde banconiere in poliestere-cotone

cod. BFPCBA

Falde senza pettorina lunghe con aperture
per accesso alle tasche.

Composizione tessuto:

65% poliestere - 35% cotone

Grammatura tessuto: 240 gr/mq

Misure indicative: cm 96x89h

Box: da 50 pz.



BFPCBANE
nero



BFPCBABO
bordeaux



BFPCBARO
rosso
(ad esaurimento)



BFPCBABO
bordeaux



BFPCBANE
nero



BFPCBABO
bordeaux



BFALBOTA
bordeaux

Falde Laccio Regolabile

cod. BFAL BOTA / NETA

Falde con pettorina, con tascone e laccio regolabile in altezza.

Composizione tessuto:

100% cotone sanforizzato

Grammatura tessuto: 240 gr/mq

Misure indicative: cm 70x90h
con tascone cm 30x30

Box: da 50 pz.



BFALBOTA
bordeaux



BFALNETA
nero



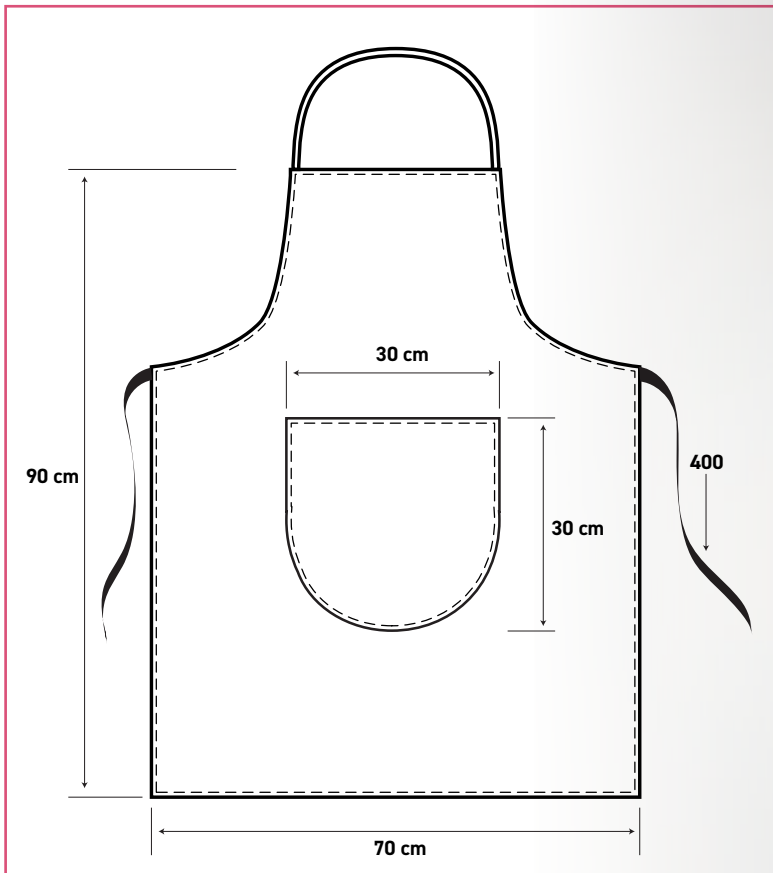

BFALNETA
nero





BFALKIAZ
royal

Falde Kiparis con pettorina

cod. BFALKI

Falde "Kiparis" con pettorina,
senza tasca.

Composizione tessuto:

100% cotone sanforizzato

Grammatura tessuto: 240 gr/mq

Misure indicative: cm 70x90h

Box: da 50 pz.



BFALKIBL
blu



BFALKIVE
verde



BFALKIAZ
royal



BFALKIBL
blu

Falde Kiparis con pettorina e tasca

cod. BFALTABL

Falde "Kiparis" con pettorina e tasca.

Composizione tessuto:

100% cotone sanforizzato

Grammatura tessuto: 240 gr/mq

Misure indicative: cm 70x90h
con tasca cm 17x20

Box: da 50 pz.



BFALTABL
blu



BFALKIVE
verde



BFALKIAZ
royal



BFALKI79
bianco

Falde Kiparis con pettorina

cod. BFALKI79

Falde "Kiparis" con pettorina
senza tasca.

Composizione tessuto:
100% cotone sanforizzato

Grammatura tessuto: 240 gr/mq

Misure indicative: cm 70x90h

Box: da 50 pz.



BFALKI79
bianco



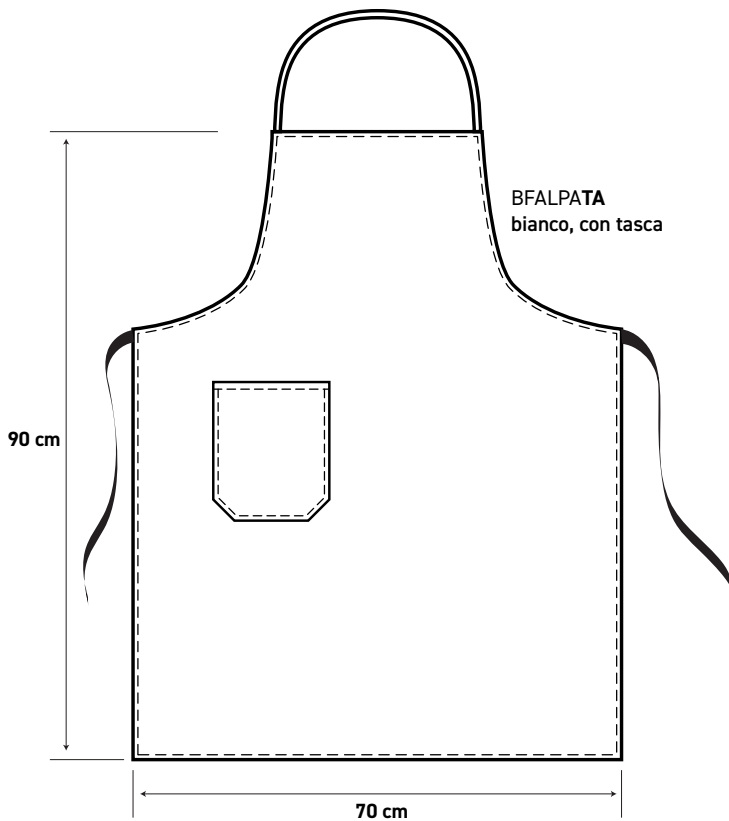

Falde Patrich con pettorina

cod. BFALPA

Falde "Patrich" con pettorina, senza tasca o con tasca 17x20.

Composizione tessuto:

100% cotone sanforizzato

Grammatura tessuto: 200 gr/mq

Misure indicative:

BFALPA79: cm 70x90h

BFALPATA: cm 70x90h con tasca cm 17x20

Box: da 50 pz.



BFALPA TA / 79
bianco

BFALPA79
bianco, senza tasca





BFALKI84
bianco

Falde Kiparis senza pettorina

cod. BFALKI84

Falde "Kiparis" senza pettorina.

Composizione tessuto:

100% cotone sanforizzato

Grammatura tessuto: 240 gr/mq

Misure indicative: cm 80x40h

Box: da 50 pz.

BFALKI84
bianco

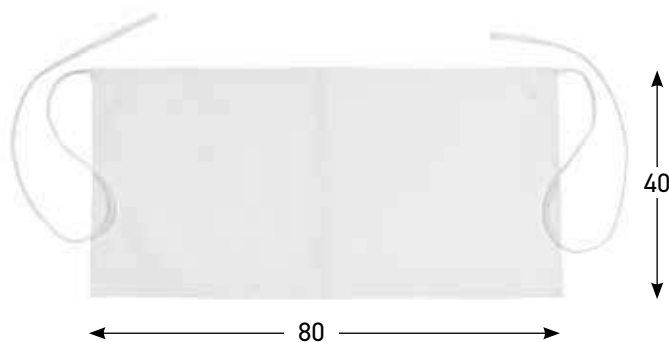

Falde Kiparis senza pettorina

cod. BFALKI67

Falde "Kiparis" senza pettorina.

Composizione tessuto:

100% cotone sanforizzato

Grammatura tessuto: 240 gr/mq

Misure indicative: cm 70x60h

Box: da 50 pz.



Falde Patrich senza pettorina

cod. BFALPA67

Falde "Patrich" senza pettorina.

Composizione tessuto:

100% cotone sanforizzato

Grammatura tessuto: 200 gr/mq

Misure indicative: cm 70x60h

Box: da 50 pz.

BFALKI67 - BFALPA67
bianco

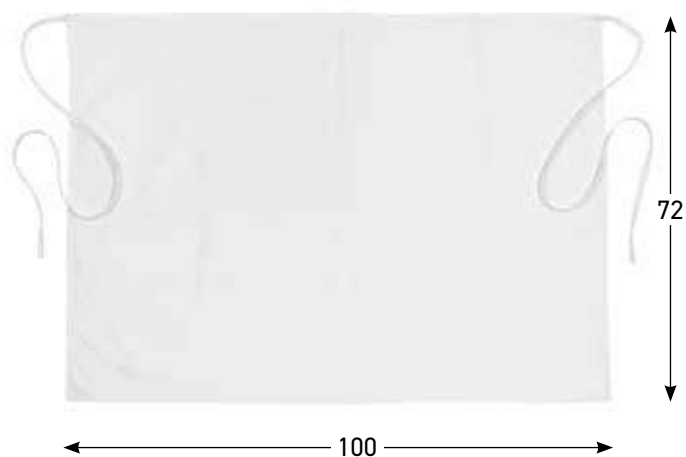

Falde Kiparis senza pettorina

cod. BFALKI71

Falde "Kiparis" senza pettorina.

Composizione tessuto:

100% cotone sanforizzato

Grammatura tessuto: 240 gr/mq

Misure indicative: cm 100x72h

Box: da 50 pz.



BFALKI71
bianco

BFALKI71
bianco



Strofinaccio Torcione

cod. BSTROF

Strofinaccio spinato bianco.
I colori delle bande sono assortiti.

Composizione tessuto:
100% cotone

Misure indicative:
68: cm 60x80 con banda colorata
WH: cm 60x70

Box: da 100 pz.

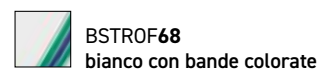



forniture
promozionali



CPOLMLME
melange



Polo manica lunga

cod. CPOLML

Polo manica lunga, 3 bottoni.

Composizione tessuto:

100% cotone

Grammatura tessuto: 180 gr/mq

Taglie: dalla S alla XXL

Box: da 30 pz. per taglia



CPOLMLME
melange



CPOLMLBL
blu

CPOLMLBL
blu



Polo mezza manica

cod. CPOL18

Polo mezza manica, 3 bottoni.

Composizione tessuto:

100% cotone

Grammatura tessuto: 180 gr/mq

Taglie: dalla S alla XXL

Box: da 30 pz. per taglia



CPOL18BI
bianco



CPOL18BL
blu



CPOL18ME
melange



CPOL18BI
bianco

CPOL18BL
blu



CPOL18ME
melange



Felpa "One Way" con zip lunga

cod. CFEL32GR

Felpa con zip lunga, collo a lupetto, due tasche, righe a contrasto su collo, polsi e vita.

Composizione tessuto:

80% cotone - 20% poliestere

Grammatura tessuto:

320 gr/mq

Taglie:

dalla S alla XXXL

Box: da 20 pz. per taglia

CFEL32GR



T-shirt mezza manica

cod. CTSH40

T-Shirt girocollo mezza manica.

Composizione tessuto:

100% cotone

Grammatura tessuto:

140 gr/mq

Taglie:

dalla S alla XXL

Box: da 60 pz. per taglia

 CTSH40ME
melange

 CTSH40BI
bianco

 CTSH40BL
blu

 CTSH40NE
nero

CTSH40ME
melange



CTSH40BI
bianco



CTSH40BL
blu

Cappellino 5 pannelli

cod. K18040

Cappellino 5 pannelli in cotone.
Visiera rigida precurvata e chiusura in
velcro. Cappellino adatto alla stampa
serigrafica, ricamo e transfer.

Composizione tessuto: 100% cotone

Taglie: unica

Box: da 50 pz. per colore

K18040AR
arancio



K18040BO
bordeaux

K18040RO
rosso

K18040BI
bianco

K18040KA
kaki

K18040GI
giallo

K18040GR
grigio

K18040VM
verde militare

K18040VI
verde inglese

K18040VE
verde

K18040VA
verde acido

K18040NE
nero

K18040BL
blu navy

K18040RY
royal





Cappellino 5 pannelli bicolore

cod. K18040

Cappellino 5 pannelli in cotone. Visiera precurvata in contrasto e chiusura in velcro. Cappellino adatto alla stampa serigrafica, ricamo e transfer.

Composizione tessuto: 100% cotone

Taglie: unica

Box: da 50 pz. per colore

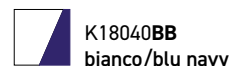

chiedere disponibilità



Cappellino bandiera italiana

cod. K18144

Cappellino 5 pannelli in poliestere-cotone con applicazione bandiera italiana. Visiera rigida precurvata con piping e sottovisiera a contrasto, chiusura regolabile con velcro.

Composizione tessuto:
65% poliestere - 35% cotone

Taglie: unica

Box: da 50 pz. per colore



Berretto zuccotto in acrilico

cod. **K18070**

Zuccotto in acrilico doppio strato, peso 70gr.

Composizione tessuto: acrilico

Taglie: unica

Box: da 200 pz. per colore



K18077NE
nero

K18077GR
grigio



K18077VM
verde militare

K18077BL
blu navy



K18077RO
rosso

K18077RY
royal



K18077CM
mimetico

Berretto zuccotto in pile

cod. **K18077**

Zuccotto in pile con targhetta in nylon (cm 5,5x3).

Composizione tessuto: pile

Grammatura tessuto: 220 gr/mq

Taglie: unica

Box: da 50 pz. per colore



Cappellino con paraorecchie

cod. K18075

Cappellino 4 pannelli in nylon e pile. Visiera rigida precurvata, caldo pile all'interno e nei paraorecchie, resistente nylon all'esterno, chiusura con cordino elastico.

Composizione tessuto: pile/nylon

Taglie: unica

Box: da 24 pz. per colore



K18075CM
mimetico



K18075NE
nero



K18075VM
verde militare



K18075BL
blu navy



K18075GR
grigio



K18076BI
bianco

K18076AR
arancio

K18076CM
mimetico

K18076KA
kaki

K18076VM
verde militare

K18076NE
nero

K18076BL
blu navy

K18076RY
royal

K18076GR
grigio

Fascia pile multiuso

cod. K18076

Fascia multiuso in pile antipilling, chiusura su un lato con laccio elastico regolabile, dimensioni 26x25 cm.

Composizione tessuto: pile

Grammatura tessuto:
220 gr/mq

Taglie: unica

Box: da 50 pz. per colore





Giubbotto New Finland

cod. PNFINL

Giubbotto con maniche staccabili, interno collo in pile antipilling, tirazip in tessuto tricolore, alamari sulle spalle con bottoni, tasca sul petto con portabagde a scomparsa, due doppie tasche esterne con bottoni, una tasca interna portafoglio, polsini elastici regolabili con velcro, fondovita con elastico, bottoni automatici in metallo.

Composizione tessuto:

poliestere pongee,
spalmatura in PVC, impermeabile,
fodera ed imbottitura in poliestere

Taglie:

per colore nero, royal e grigio:
dalla S alla XXXL

per colore blu navy: dalla XS alla 4XL

Box: da 10 pz. per taglia

	PNFINLBL blu navy
	PNFINLNE nero
	PNFINLGR grigio
	PNFINLRY royal



maniche
staccabili



Giubbotto New Scotland

cod. PNSCOT

Giubbotto con maniche staccabili, profili infrangenti, tasca sul petto con portabagde a scomparsa e portacellulare interno, due doppie tasche con patta e chiusura in velcro, due tasche con zip con fodera rinforzata per utensili, una tasca interna portafoglio, un taschino interno portacellulare, polsini con elastico regolabile con velcro, bottoni automatici in metallo.

Composizione tessuto:

65% poliestere - 35% cotone traspirante con trattamento antipioggia, fodera ed imbottitura in poliestere.

Taglie:

per colore nero, verde, grigio, rosso, royal:
dalla M alla XXXL
per colore blu navy: dalla XS alla 4XL

Box: da 10 pz. per taglia

	PNSCOTBL blu navy		PNSCOTNE nero
	PNSCOTRO rosso		PNSCOTGR grigio
	PNSCOTRY royal		PNSCOTVE verde



ad esaurimento scorte



maniche
staccabili





Gilet Great Britain

cod. PGBRIT

Gilet con profili rinfrangenti, tasca sul petto con portabagde a scomparsa e con portacellulare, doppie tasche con patta e chiusura in velcro, due tasche con zip sul petto con taschino interno portacellulare, tasca interna portafoglio con velcro, taschino interno portacellulare, elastico antivento nel giromanica, elastico stringifianchi, bottoni automatici in metallo.

Composizione tessuto:

65% poliestere - 35% cotone traspirante con trattamento antipioggia, fodera ed imbottitura in poliestere

Taglie:

per colore royal, nero, rosso e verde:
dalla S alla XXXL

per colore blu navy e grigio: dalla S alla 4XL

Box: da 15 pz. per taglia

	PGBRITRO rosso		PGBRITGR grigio
	PGBRITBL blu navy		PGBRITNE nero
	PGBRITRY royal		PGBRITVE verde

ad esaurimento scorte



Felpe New Singapore

cod. PNSING

Felpe con collo a lupetto, zip corta, cuciture e profili in contrasto, tasca con portabadge sul braccio e bandierina tricolore, nastro di rinforzo al collo tricolore, collo, polsini e fondo maglia in costina elasticizzata, mezzaluna di rinforzo dietro il collo.





Composizione tessuto:

65% poliestere - 35% cotone

Grammatura tessuto: 280 gr/mq

Taglie: dalla S alla XXXL

Box: da 20 pz. per taglia

	PNSINGRO rosso		PNSINGGR grigio
	PNSINGBL blu navy		PNSINGNE nero



A young man with a beard and mustache, wearing a bright yellow hard hat and an orange safety vest over a black shirt, is smiling and looking towards the right. He is operating a piece of machinery in a factory or industrial setting. The background is filled with industrial equipment and structures, with a warm, golden light illuminating the scene. The text 'forniture antinfortunistiche' is overlaid in white on a semi-transparent orange band across the lower part of the image.

forniture
antinfortunistiche



Giubbino Alta Visibilità

cod. AA2GIUAR (arancio)

Giubbino con bottoni coperti, due tasche anteriori con pattina e bottone al petto, bottone ai polsi.

CE SECONDA CATEGORIA CLASSE 3

Norma di riferimento: UNI EN 20471: 2013

Norma di riferimento: UNI EN 13688: 2013

Composizione tessuto:

65% cotone - 35% poliestere
con bande rinfrangenti

Grammatura tessuto: 210 gr/mq

Taglie: dalla M alla 3XL

(dalla 44 alla 64 **ad esaurimento**)

Box: da 18 pz. per taglia

Pantalone Alta Visibilità

cod. AA2PANAR (arancio)

Pantalone lavoro con bottoni coperti, due tasche anteriori, tasca posteriore con bottone, portametro.

CE SECONDA CATEGORIA CLASSE 2

Norma di riferimento: UNI EN 20471: 2013

Norma di riferimento: UNI EN 13688: 2013

Composizione tessuto:

65% cotone - 35% poliestere
con bande rinfrangenti

Grammatura tessuto: 210 gr/mq

Taglie: dalla S alla 3XL

(dalla 44 alla 64 **ad esaurimento**)

Box: da 18 pz. per taglia





Salopette Alta Visibilità

cod. AA2SALAR (arancio)

Salopette lavoro con apertura laterale con bottoni, elastico in vita, tessuto salvareni, ganci in plastica, tasche anteriori, tascone con cerniera, tasca posteriore con bottone, portametro.

CE SECONDA CATEGORIA CLASSE 2

Norma di riferimento: UNI EN 20471: 2013

Norma di riferimento: UNI EN 13688: 2013

Composizione tessuto:

65% cotone - 35% poliestere con bande rinfrangenti

Grammatura tessuto: 210 gr/mq

Taglie: dalla M alla XXL

(dalla 44 alla 64 **ad esaurimento**)

Box: da 15 pz. per taglia



Tuta Alta Visibilità

cod. AA2TUTAR (arancio)

Tuta lavoro con cerniera coperta, elastico posteriore in vita, due taschini con pattina e bottone al petto, due tasche anteriori, tasca posteriore con bottone, portametro.

CE SECONDA CATEGORIA CLASSE 3

Norma di riferimento: UNI EN 20471: 2013

Norma di riferimento: UNI EN 13688: 2013

Composizione tessuto:

65% cotone - 35% poliestere
con bande rinfrangenti

Grammatura tessuto:

210 gr/mq

Taglie: dalla M alla 3XL

(dalla 44 alla 64 **ad esaurimento**)

Box: da 10 pz. per taglia



Parka 5 usi Alta Visibilità

cod. AAVPR5

Parka ad alta visibilità 5 usi, impermeabile, cappuccio a scomparsa. Interno staccabile con maniche staccabili, reversibile.

CE

giaccone esterno:

SECONDA CATEGORIA CLASSE 3

giacca interna (senza maniche):

SECONDA CATEGORIA CLASSE 2

Norma di riferimento: UNI EN 20471: 2013

Norma di riferimento: UNI EN 13688: 2013

Taglie: dalla M alla XXL

Box: da 10 pz. per taglia

 AAVPR5AB
arancio/blu

 AAVPR5GB
giallo/blu





Parka Alta Visibilità

cod. AAVPRK

Parka fisso ad alta visibilità, impermeabile, cappuccio a scomparsa.

CE SECONDA CATEGORIA CLASSE 3

Norma di riferimento: UNI EN 20471: 2013

Norma di riferimento: UNI EN 13688: 2013

Taglie: dalla M alla XXL

Box: da 10 pz. per taglia



Gilet Alta Visibilità

cod. NGILAV

Gilet ad alta visibilità.

CE SECONDA CATEGORIA CLASSE 2

Norma di riferimento: UNI EN 20471: 2013

Norma di riferimento: UNI EN 13688: 2013

Composizione tessuto:

100% poliestere con bande rinfrangenti

Taglie: unica

Box: da 50/100 pz. per taglia



NELMPOGI
giallo

NELMPOBI
bianco

NELMPOAR
arancio



NELMPOBL
blu



NELMPORO
rosso

NELMPOVE
verde

Elmetto in polietilene

cod. NELMPO

Elmetto in polietilene omologato CE EN 397 con fori per sottogola, calotta interna fornita smontata.

Taglie: unica

Box: da 60 pz.



Stivale antinfortunistico

cod. NSTIAN

Stivale antinfortunistico con puntale e lamina in acciaio.

CE S5 - SRC

Norma di riferimento: EN ISO 20345:2011 SRC

Taglie: dalla 37 alla 47 **Box:** da 5 paia per taglia



NSTIANVE
verde



NSTIANGI
giallo



NSTIANVE
verde

Stivale nitrile bianco

cod. NSTINIBI (bianco)

Stivale in pvc nitrilico bianco.

CE Norma di riferimento:

EN ISO 20347:2012 SRA

Taglie: dalla 38 alla 46

Box: da 8 paia per taglia

ad esaurimento scorte



Innovazione al servizio della **sicurezza** e del **benessere**

Ammortizzazione: l'intersuola infnergy® trattiene e restituisce l'energia accumulata ad ogni passo.



**DISPONIBILI
ALTRI MODELLI
SU ORDINAZIONE**

Point cod. **NRL20036**

Tomaia:

Nylon ultra traspirante e morbida pelle scamosciata, soffetto nylon imbottito

Taglie: dalla 38 alla 48

Box: da 10 paia per taglia



Fodera a tunnel d'aria che garantisce elevata traspirabilità



Puntale forato con membrana resistente a 200J



Intersuola antiperforazione non metallica, 100% della superficie protetta



Intersuola composta da migliaia di capsule che trattengono e restituiscono l'energia accumulata ad ogni tuo passo abbinata ad un inserto in gel defaticante. Suola in PU/PU per un comfort ottimale e con eccezionale coefficiente di resistenza allo scivolamento. Tacco preformato di altezza 6 mm polifunzionale.



Soletta anatomica in PU antibatterico e traspirante con canali per circolazione d'aria

RESISTENZA ALLO SCIVOLAMENTO

		VALORI MINIMI		Red Lion
SRC (SRA+SRB)	SRA	Pianta	0,32	0,82
	Tacco	0,28	0,60	
SRB	Pianta	0,18	0,30	
	Tacco	0,13	0,18	

REQUISITI DI RESISTENZA ALLO SCIVOLAMENTO SECONDO LA EN ISO 20345:2011 CON METODO SECONDO LA EN 13297:2002



rapido sfilamento

BEST PRICE

Safe
NUE10013

S3 RS SRC CE

Simple
NUE20013

S3 SRC CE



Safe cod. NUE10013

Simple cod. NUE20013

VERSIONE ALTA CON RAPIDO SFILAMENTO

Tomaia: Pelle stampata, idrorepellente

Puntale: Acciaio

Antiperforazione: Lamina acciaio ergonomica

Taglie: dalla 35 alla 48

Box: da 10 paia per taglia

Movida cod. NUE20025

Tomaia: Pelle scamosciata forata

Puntale: Acciaio

Antiperforazione: Lamina acciaio ergonomica

Taglie: dalla 35 alla 48

Box: da 10 paia per taglia

BEST PRICE

Movida
NUE20025

S1P SRC CE



Rotational
NBN20035

S1P SRC CE



Rotational cod. NBN20035

Tomaia: Pelle scamosciata grigia forata

Puntale: Acciaio

Antiperforazione: Lamina acciaio ergonomica

Taglie: dalla 35 alla 48

Box: da 10 paia per taglia

Anaconda cod. NBN10025

Soffietto cod. NBN20025

VERSIONE ALTA CON RAPIDO SFILAMENTO

Tomaia: Pelle stampata

Puntale: Acciaio

Antiperforazione: Lamina acciaio ergonomica

Taglie: dalla 35 alla 48

Box: da 10 paia per taglia

Soffietto
NBN20025

S1P SRC CE



rapido sfilamento

Anaconda
NBN10025

S1P RS SRC CE



Introduzione alle norme di sicurezza per calzature e stivali

Le calzature da lavoro a Norma UNI EN ISO 20345:2011 sono contraddistinte da una "S" (dall'inglese Safety = Sicurezza) come "Calzature di Sicurezza".

La calzatura cosiddetta "di Base" è marcata con le lettere "SB" (S = Sicurezza - "B" = Base) e deve sottostare ai requisiti minimi previsti per legge, tra i quali la presenza del puntale di protezione.

Le calzature da lavoro a Norma UNI EN ISO 20347:2012 vengono denominate "Calzature da lavoro" o "professionali".

Si differenziano dalla precedente categoria per non avere il puntale di protezione. Queste calzature sono contraddistinte dalla lettera "O".

Simbologia delle norme di sicurezza degli articoli a catalogo:

SB

S1 (A+FO+E)

S1P (A+FO+E+P)

S2 (A+FO+E+WRU)

S3 (A+FO+E+WRU+P)

S4 (A+FO+E)

S5 (A+FO+E+P)

SRC resistenza della suola allo scivolamento SRA+SRB

A suola antistatica

FO suola di contatto resistente agli idrocarburi

E assorbimento energia del tallone

P lamina antiperforazione

WRU impermeabilità dinamica della tomaia $\geq 60'$

Nota:

Tutte le calzature e gli stivali a catalogo con puntale rispondono ai requisiti richiesti dalla normativa UNI EN ISO 20345:2011.

Tutte le calzature e gli stivali a catalogo senza puntale rispondono ai requisiti richiesti dalla normativa UNI EN ISO 20347:2012.

In alternativa alle tradizionali protezioni, sono ora disponibili protezioni frutto delle nuove tecnologie:



Puntale AirToe Composite
(gr 50 circa)



Puntale AirToe Aluminum
(gr 54 circa)



Soletta antiperforazione "no metal"

I rivoluzionari puntali di sicurezza, versatili, leggeri e traspiranti grazie alla combinazione di una foratura asimmetrica e di una speciale membrana a microfori permettono l'eliminazione del sudore sotto forma di vapore acqueo e consentono al piede di respirare. AirToe, oltre a rispondere alle più severe norme di sicurezza, garantisce la perfetta impermeabilità e l'assoluta traspirabilità anche dopo molte ore di uso intensivo.

Offre protezione del piede al 100% in quanto potendo essere cucita direttamente sulla tomaia garantisce la protezione dell'intera pianta del piede, non rilevabile al metal detector, leggera, flessibile, migliora l'isolamento termico.

Ordini

Per l'invio dei Vostri ordini potete fotocopiare il modulo prestampato nella pagina a fianco.

Conversione taglie

Taglie italiane Italian sizes	40	42	44	46	48	50	52	54	56	58	60	62	64
Taglie americane American sizes	XS	S		M		L		XL		XXL		XXXL	
Taglie camicie Shirt sizes	36	37	38	39	40	41	42	43	44	45	46	47	48

Note

Per ragioni tecniche lievi differenze di tonalità di colore si possono riscontrare nelle forniture del medesimo articolo, tali differenze non costituiscono variazioni di qualità del prodotto.

La grammatura indicata si riferisce al prodotto colorato. Tolleranza delle grammature indicate +/-5%.

La direzione si riserva di apportare modifiche, miglioramenti ai capi in catalogo o di sospendere la produzione di taluni senza preavviso.

La garanzia della nostra società è espressamente limitata alla sostituzione del capo riconosciuto difettoso. Si esclude ogni altra indennità e risarcimento per danni su capo lavorato.

I colori dei capi riprodotti sono indicativi. È vietata qualsiasi riproduzioni non autorizzata, anche parziale, del presente catalogo.



Global Trading s.r.l.

Via Roma, 2B int. 4 - 31020 Lancenigo di Villorba (TV)
magazzino: via Marmolada, 9 - 31027 Spresiano (TV)
tel. 0422 910243 / 911542 - fax 0422 911658
www.global-trading.it - info@global-trading.it